

東莞永力電業有限公司

YUNG LI CO., LTD

Da Pu Industrial Zone, Gang Zi, Changping Town,
Dong Guan City, Guangdong 523571 China.P.R.C

TEL:0769-83396797~8

FAX:0769-83396796

E-mail: sales@yung-li.com

Description: YP-80/YC-12

Customer: MAG

Parts No. : CB-N-IND-5M-V1

Draw No. :

REVISION RECORD

1		
2		
3		
4		
5		

YUNG LI	
CHECKED	PREPARED BY

CUSTOMER	APPROVED

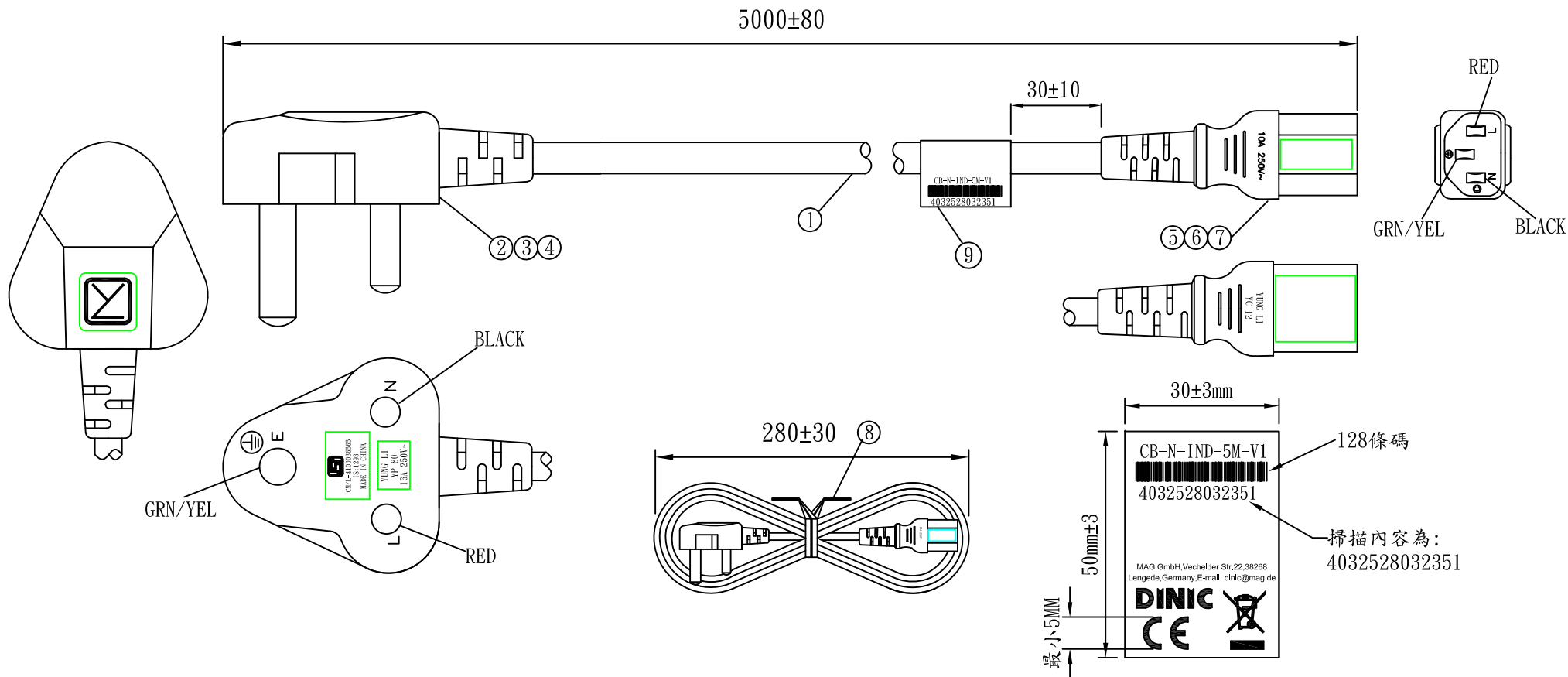

NO.	SPECIFICATION	QTY	REMARK
1	Y Y 3G 1.5mm ² CIRCULAR BLACK	1PC	
2	YP-80 TPV PLASTIC:60P BLACK	50g/PC	
3	YP-80 TER:P98010A-1W	1PC	
4	YP-80 TER:P98010B-B	1PC	
5	TER:97740	3PCS	
6	YC-12 INNER BODY	1PC	
7	YC-12 PVC PLASTIC:50P BLACK	18g/PC	
8	MINI TIE:L=210mm BLACK	1PC	
9	LABEL:50X30mm	1PC	

Marking:

Yung Li Co. Ltd. Y Y 3C 1.5mm² CIRCULAR 1100V IS 694  CM/L-4041337 MADE IN CHINA

TOLERANCE	APPROVED	DATE		YUNG LI CO.,LTD			
	CHECKED	DATE					
>0±0.30							
>1.0±0.50							
>10.0±1.0	DRAWN	SUKI	DATE	24.06.27	CUSTOMER	MAG	
>20.0±2.0	TYPE	YP-80/YC-12			P/N	CB-N-IND-5M-V1	
Angle:	DRAWING NO.	CY-B0789	REV	B	MATERIAL	P.V.C	UNIT
±1°					SCALE		

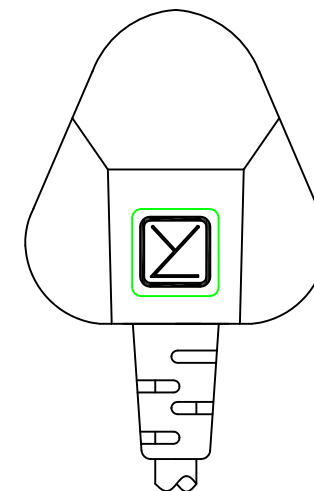
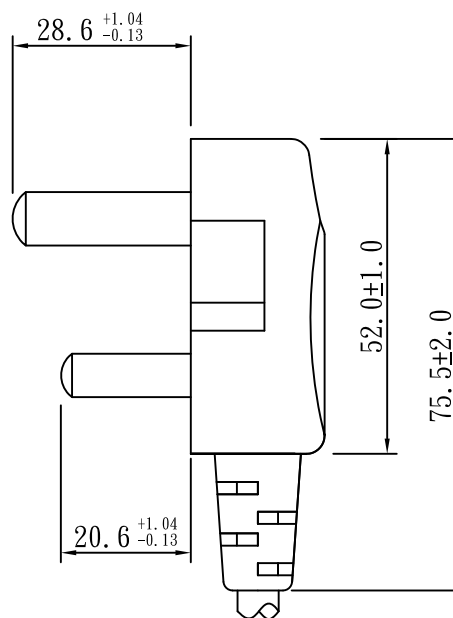
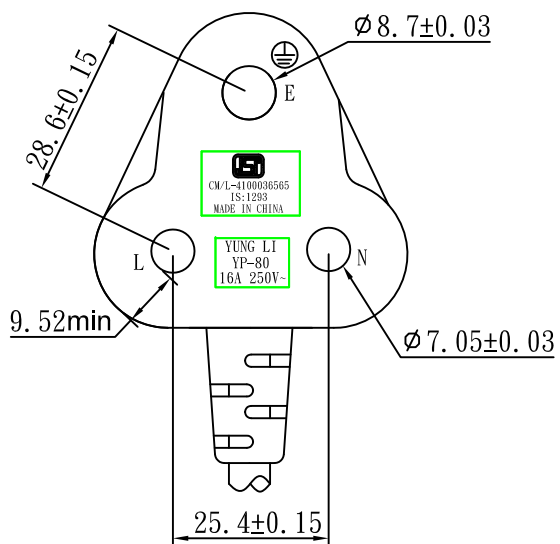
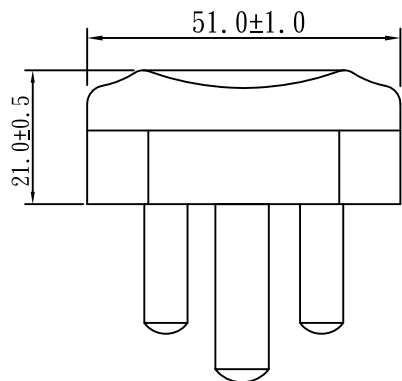

TOLERANCE >0±0.30 >1.0±0.50 >10.0±1.0 >20.0±2.0 Angle: ±1°	APPROVED		DATE		YUNG LI CO., LTD			
	CHECKED		DATE					
	DRAWN		DATE		CUSTOMER			
	TYPE	YP-80(BIS)			P/N			
	DRAWING NO.	MP-B80000	REV	B	MATERIAL	P. V. C	UNIT	mm
					SCALE	1:1		

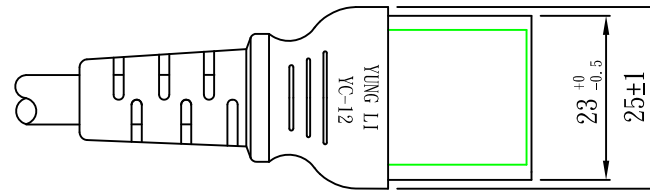
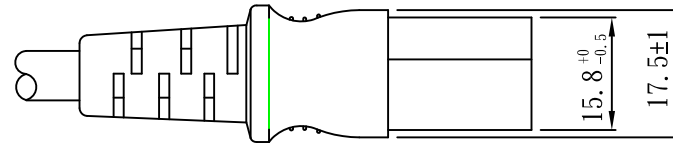
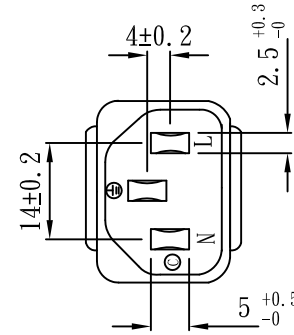
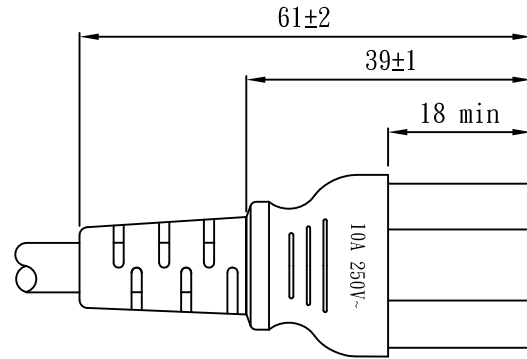

TOLERANCE >0±0.30 >1.0±0.50 >10.0±1.0 >20.0±2.0 Angle: ±1°	APPROVED		DATE		YUNG LI CO., LTD			
	CHECKED		DATE					
	DRAWN		DATE		CUSTOMER			
	TYPE	YC-12			P/N			
	DRAWING NO.		REV	B	SCALE	1:1	UNIT	mm

YUNG LI CO., LTD

SPECIFICATION

Yung Li	Style	PVC FLEXIBLE CORDS	Document No
2022.07.22			
Edition	Size	Y Y 3C 1.5mm²	Page
A			1/2

1. Standard: IS 694

2. Construction & Dimension

	Item	Specification
Conductor	Size	3G 1.5mm ²
	Material	Annealed Bare Copper
	Construction	48/ § 0.202±0.01
Insulation	Material	PVC
	Minimum Average Thickness	0.70mm
	Minimum Thickness at any point	0.56mm
	Diameter	3.05± 0.10
	Identification	RED,BLACK,Green/Yellow
Core Assembly	Core Twist	3-Core
	Filler	NA
Shielded	A1-Mylar Foil	NA
Drain	Material	NA
	Construction	NA
Jacket	Material	NA
	Minimum Average Thickness	0.9mm
	Minimum Thickness at any point	0.72mm
	Overall Diameter(Approx)	8.6± 0.15
	Color	Any colour

Marking:

Yung Li Co. Ltd. Y Y 3C 1.5mm² CIRCULAR 1100V IS 694  CM/L-4041337 MADE IN CHINA

YUNG LI CO., LTD

SPECIFICATION

Yung Li	Style	PVC FLEXIBLE CORDS	Document No
2022.07.22			
Edition	Size	Y Y 3C 1.5mm²	Page
A			2/2

4. Electrical & Physical Properties

Item	Specification		
Rating Voltage	70°C 300/500V		
Conductor resistance(AT 20°C)	13.3Ω/Km Max		
Dielectric Strength	AC 6.0 KV / 5 min No Break		
Spark Test	6.0KV		
Insulation	Unaged	Tensile Strength	12.5N/mm ² min
		Elongation	150% Min
	Aged	Tensile Strength	80~120% (80°C x168hrs)
		Elongation	80~120% (80°C x168hrs)
	Loss of mass Test		2.0mg/cm ² (max)
Jacket	Unaged	Tensile Strength	12.5N/mm ² min
		Elongation	150% Min
	Aged	Tensile Strength	80~120% (80°C x168hrs)
		Elongation	80~120% (80°C x168hrs)
	Loss of mass Test		2.0mg/cm ² (max)
Deformation Test	80±4°C X 1hr ≤ 50%		
Cold Bend Test	-15°C x 4hr No Crack		
Heat Shock Test	150±2°C x 1hr No Crack		

Graph:

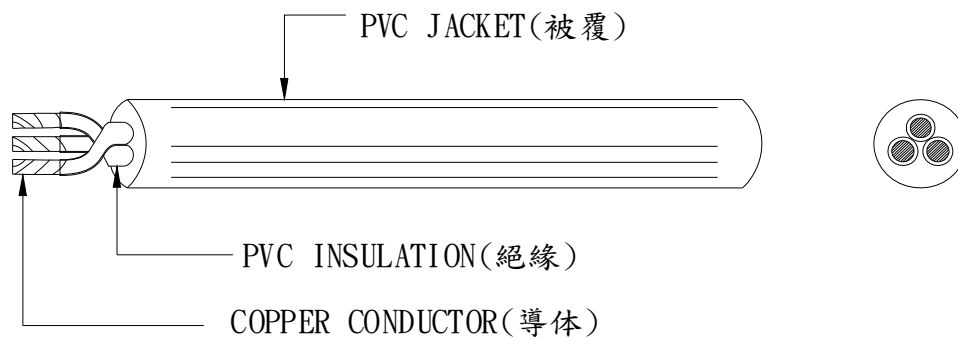



AIRMAIL/SPEED POST

Our Ref: FMCD-CM/L-4100036565

20-07-2020

Subject: RENEWAL OF CERTIFICATION MARKS LICENCE NO. CM/L- 4100036565
AS PER IS 1293: 2019

M/s Dongguan Yung Li Co. Ltd.,
Da Pu Industrial Zone, Gangzi,
ChangPing Town, DongGuan City
Changping District, GuangDong State,
P.R. China - 523571

Dear Sir,

With reference to your application for renewal of the above mentioned Certification Marks Licence, we are pleased to inform you that it has been renewed from **19/07/2020 to 18/07/2025**.

It may please be noted that your licence shall expire at the end of the above mentioned period. You are, therefore, requested to send your application along with fee for its renewal at least one month before the expiry of the licence.

It may also be noted that the Performance Bank Guarantee of US\$ 10,000.00 submitted by you is valid upto 11.09.2021. Since as per the revised guidelines the Bank Guarantee should have a validity of six months more than the validity of the licence therefore, you are advised to get the validity of the Bank Guarantee extended accordingly. You are directed to submit revised Performance Bank Guarantee before its validity date, failing which we may be constrained to take action such as stop marking/cancellation of the BIS licence as enshrined in the BIS (Certification) Regulation, 2016. Please ensure extension of PBG as early as possible.

The endorsement sheet regarding revision of marking fee and renewal of licence are enclosed. This may be annexed to the original licence document available with you.

Thanking you.

Yours faithfully,

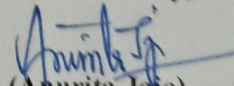
(Anurita Jojo)
Sc. D (FMCD)

Encl: As above

Copy to:

Mr. Prakash Taunk
239, Nagpur Road,
Madan Mahal, Jabalpur,
M.P. - 482001



भारतीय मानक ब्यूरो
BUREAU OF INDIAN STANDARDS

FMCD

Manak Bhawan, 9 Bahadur Shah Zafar
Marg,
Address New Delhi, 110002
Phones 91-11-23239382
Fax : 91-11-23239382
E-mail : fmcs@bis.org.in
Web : <http://www.bis.org.in>

ATTACHMENT TO LICENCE NO. CM/L- 4100036565

CML/NO	NAME OF THE LICENSEE WITH THE ADDRESS	NAME OF THE PRODUCT	IS NO.
4100036565	M/s Dongguan Yung Li Co. Ltd., Da Pu Industrial Zone, Gangzi, ChangPing Town, DongGuan City Changping District, GuangDong State, P.R. China - 523571	Plugs and socket – outlets of rated voltage upto and including 250 volts and rated current upto and including 16 amperes, Specification	IS 1293:2005

ENDORSEMENT NO. 03 DATED 06-05-2020

Consequent upon the revision of IS 1293:2005 as IS 1293:2019, the Indian Standard number specified in the schedule of the licence stands revised as under with effect from **Sixth May Two Thousand Twenty**.

IS 1293:2019 Plugs and socket – outlets for household and similar purposes of rated voltage upto and including 250 volts and rated current upto and including 16 amperes, Specification

Consequent upon the above revision, the scope of the licence had been revised as under w.e.f. Sixth May Two Thousand Twenty

Moulded Plugs of following varieties as per IS 1293:2019

1	Ampere & Voltage rating	6 A, 250V, AC	6 A, 250V, AC	16 A, 250V, AC
2	Rewireable/Non Rewireable	Non Rewireable	Non Rewireable	Non Rewireable
3	No. of Pin	3 pin	2 pin	3 pin
4	Round/Flat	Round	Round	Round
5	Solid/not solid	Solid	Solid	Solid
6	With/without sleeves	Without insulating sleeves	With insulating sleeves	Without insulating sleeves
7	No. of poles (with/ without earthing contact)	2 Poles with earthing contact	2 poles Without earthing contact	2 poles with earthing contact
8	Type of terminal (Screw type/ Screw less terminals for rigid conductors/ Screw less terminals for rigid & flexible conductors)	Screwless terminals for rigid and flexible conductors	Screwless terminals for rigid and flexible conductors	Screwless terminals for rigid and flexible conductors
9	Suitable for class I/II appliances	for class I appliances	for class II appliances	for class I appliances
10	Degree of protection	IPX0	IPX0	IPX0

Other terms and conditions of Licence remain the same

(Anurita Jojo)
Sc.- D (FMCD)



भारतीय मानक ब्यूरो
BUREAU OF INDIAN STANDARDS

FMCD

Address : Manak Bhavan, 9 Bahadur Shah
Zafar Marg, New Delhi, 110002
Phones : 91-11-23239382
Fax : 91-11-23239382
E-mail : fmcd@bis.org.in
Web : <http://www.bis.org.in>

ATTACHMENT TO LICENCE NO. CM/L- 4100036565

CML/NO	NAME OF THE LICENSEE WITH THE FACTORY ADDRESS	NAME OF THE PRODUCT	INDIAN STANDARD NO.
4100036565	M/s Dongguan Yung Li Co. Ltd., Da Pu Industrial Zone, Gangzi, ChangPing Town, DongGuan City Changping District, GuangDong State, P.R. China - 523571	Plugs and socket- outlets of rated voltage upto & including 250 volts and rated current upto & including 16 amperes - Specification	IS 1293 : 2019

ENDORSEMENT NO. 04 DATED 20-07-2020

Whereas, the licence was valid upto Eighteenth July Two Thousand Twenty,

Now, consequent upon renewal, the validity of the licence given in endorsement No. 01 has been extended from Nineteenth July Two Thousand Twenty to Eighteenth July Two Thousand Twenty Five.

Other terms and conditions of Licence remain the same.

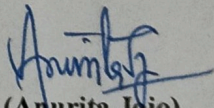
(Anurita Jojo)
Sc. D (FMCD)



AIRMAIL/SPEED POST

Our Ref: FMCD-CM/L-4041337

27-08-2020

**Subject: RENEWAL OF CERTIFICATION MARKS LICENCE NO. CM/L- 4041337
AS PER IS 694:2010**

M/s Dongguan Yung Li Co. Ltd.,
DaPu Industrial Zone,
Gangzi Changping Town,
Dongguan City,
Guangdong - 523571
China

Dear Sir,

With reference to your application for renewal of the above mentioned Certification Marks Licence, we are pleased to inform you that it has been renewed from **01/09/2020 to 31/08/2025**.

It may please be noted that your licence shall expire at the end of the above mentioned period. You are, therefore, requested to send your application along with fee for its renewal at least one month before the expiry of the licence.

It may also be noted that the Performance Bank Guarantee of US\$ 10,000.00 submitted by you is valid upto 11-09-2021. Since as per the revised guidelines the Bank Guarantee should have a validity of six months more than the validity of the licence therefore, you are advised to get the validity of the Bank Guarantee extended accordingly. You are directed to submit revised Performance Bank Guarantee before its validity date, failing which we may be constrained to take action such as stop marking/cancellation of the BIS licence as enshrined in the BIS (Conformity Assessment) Regulation, 2018. Please ensure extension of PBG as early as possible.

The endorsement sheet regarding renewal of licence is enclosed. This may be annexed to the original licence document available with you.

Thanking you.

Yours faithfully,

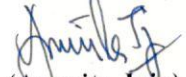
(Anurita Jojo)
Sc. D (FMCD)

Encl: As above

Copy to: **Mr. Ravinder Madan**
Planet Standards Certification Advisors
63, Bhagwan Buddha Apt, Parwana Road,
Pitampura, Delhi- 110034



भारतीय मानक ब्यूरो
BUREAU OF INDIAN STANDARDS

Address : Manak Bhavan, 9 Bahadur Shah
Zafar Marg, New Delhi, 110002
Phones : 91-11-23239382
Fax : 91-11-23239382
E-mail : fmcd@bis.org.in
Web : <http://www.bis.org.in>

FMCD

ATTACHMENT TO LICENCE NO. CML/ 4041337

CML/NO	NAME OF THE LICENSEE WITH THE FACTORY ADDRESS	NAME OF THE PRODUCT	INDIAN STANDARD NO.
4041337	M/s Dongguan Yung Li Co. Ltd., DaPu Industrial Zone, Gangzi Changping Town, Dongguan City, Guangdong - 523571 China	PVC insulated unsheathed and sheathed cables/cords with rigid & flexible conductor for rated voltages upto & including 1100 V	IS 694 : 2010

ENDORSEMENT NO. 10 DATED 27-08-2020

Consequent to the change of name and address of the Authorized Indian Representative, the name and address of the Authorized Indian Representative is as under :-

Mr. Ravinder Madan
Planet Standards Certification Advisors
63, Bhagwan Buddha Aptt, Parwana Road,
Pitampura, Delhi- 110034

Whereas, the licence was valid upto Thirty-first August Two Thousand Twenty,

Now, consequent upon renewal, the validity of the licence given in endorsement no. 09 has been extended from First September Two Thousand Twenty to Thirty-first August Two Thousand Twenty Five.

Other terms and conditions of Licence remain the same.

(Anurita Jojo)
Sc. D (FMCD)